

Identification

Type Designation	LR3 60-3/125	Type of reactor	3~ Line Reactor
Series	LR3	Core Rating	4241.15 var
Core type	3UI 120/61	Drive HP	125

Technical Data

No. of phase		3
Circuit type		III0
Rated Voltage	[V]	600
Rated current	[A]	125.0
Rated Frequency	[Hz]	50 - 60
Impedance	[%]	3.2
Inductance L	[mH]	0.240
L tolerance	[%]	±10%
Linearity		150% In
Test voltage	[kV]	4.0
Isolation System Class		Class 180

Operating conditions

Ambient temperature	[°C]	-10 ... +40°C
Ambient temperature	[F]	14 ... 104°F
Type of cooling		AN
Operating conditions		24/7

Standards

Type: VDE 0570 / EN 61 558 Part 1 VDE 0570 / EN 61 558 Part 20	Signs
--	-----------

Approvals

UL 508	E219022 NMTR
UL 5085-1	E103521 XPTQ

Variations may apply due to material's and production's tolerances. Objected to modifications without notice.

Original Date:	15/04/17	Observe protection clause to ISO 16016	Index	0
Name:	Lüning		Doc. type	
Date:	15/05/06			
Checked:	Wesner		Pages	1 of 2

Dimensions / Mounting in Inches

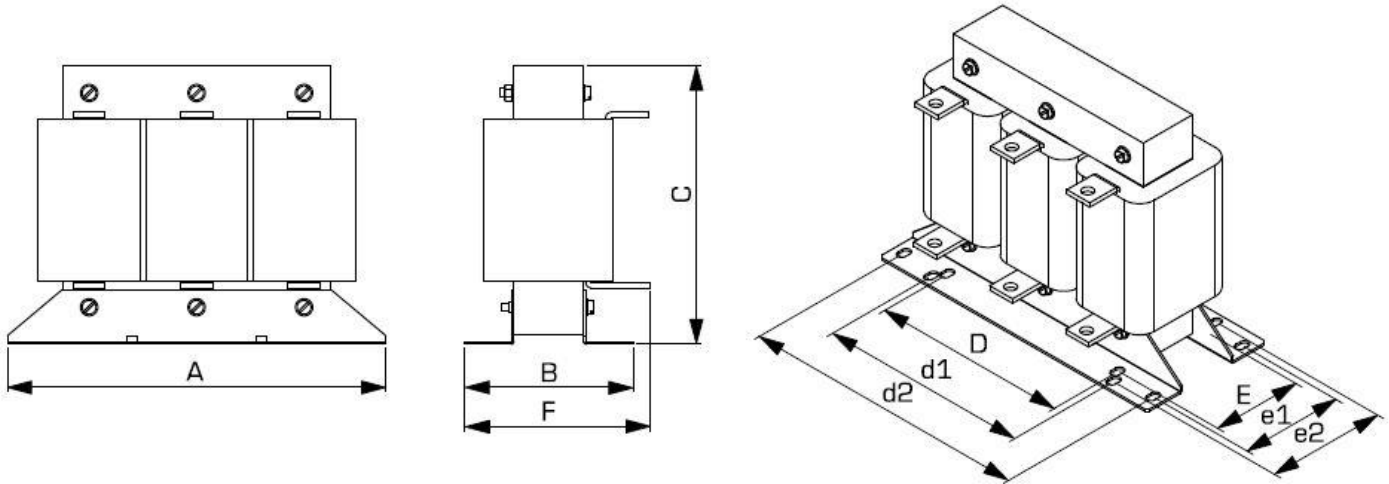

A	B	C*	F	D	d1	d2	E	e1	e2	Drill
11.46	6.26	8.31	-	10.75	7.28	-	4.72	4.72	-	0.39
										0.39
										-

* = Typical variable air gab

Weight

Weight	[kg]	22.00
	[lbs]	48.50

Notes

Technical specifications in the drawing are not binding. General tolerance to DIN 7168-m. Subject to change.
Mounting plates also available in stainless steel as OEM application. Ask for details.

Original Date:	15/04/17	Observe protection clause to ISO 16016	Index	0
Name:	Lüning		Doc. type	
Date:	15/05/06			
Checked:	Wesner		Pages	2 of 2